

la marzocco USA technical bulletin 190

linea classic s drain tray and steam knob

March 19, 2024

We would like to inform you about recent production improvements to the Linea Classic S.

To prevent water from dripping out of the drain box, the drain tray has been modified, and two copper washers L100/1A (20) are now used on each fitting in the drain box.

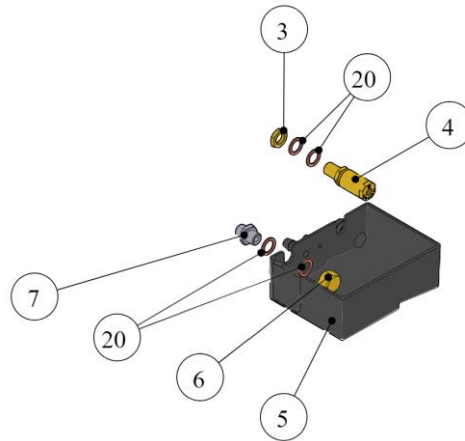

New drain tray:

The new drain tray has a raised wall on the back side to better protect the electronic box from possible water splashes. The slope has been increased, and the drain hole has been shaped to better direct the water into the drain box.

The new tray can be found on:

- One group machines starting from serial number LS009823.
- Two group machines starting from serial number LS009190 and from LS008627 to LS008979.
- Three group machines starting from serial number LS008928.
- Four group machines starting from serial number LS009774.

Machines produced prior to the serial numbers listed above have the previous version of tray.

The new tray is available as a spare part with the following part codes:

1gr: C.1.586.1.01
2gr: C.1.586.2.01
3gr: C.1.586.3.01
4gr: C.1.586.4.01



la marzocco

handmade in florence

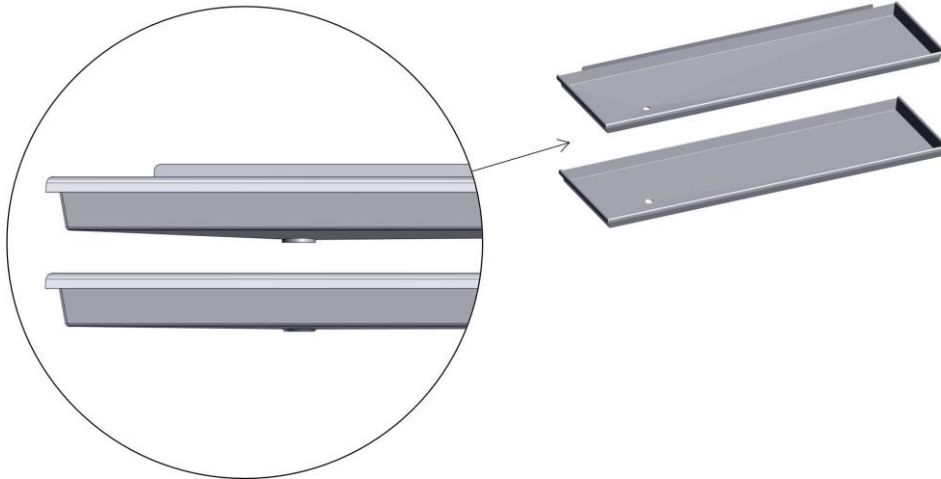

To retrofit the new tray in older machines, it may be necessary to slightly bend the brew valves drain tube backward, due to the presence of the higher wall.

New steam knob and cap:

The steam knob has been modified to reduce the temperature of its external surface, while the knob's cap has been re-designed to reduce the temperature of the attached metal plate.

The wider air cavity inside the knob allows for less heat transmission from the brass insert to the external surface.

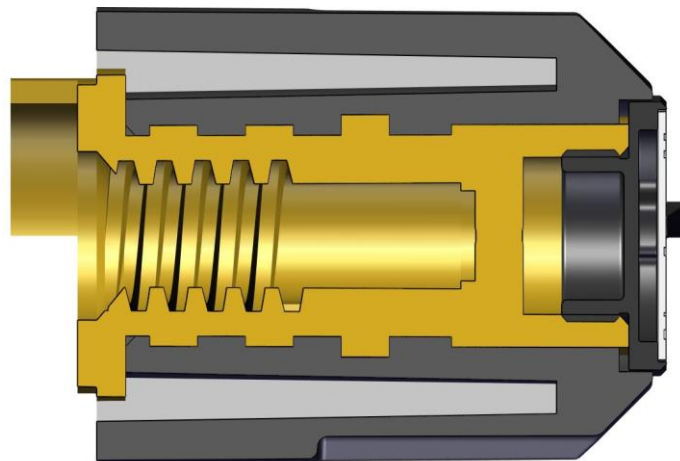

The new plastic cap is in contact with the metal plate only on a thin rim. The air gap limits heat transmission and drastically reduces the temperature of the plate.



la marzocco

handmade in florence

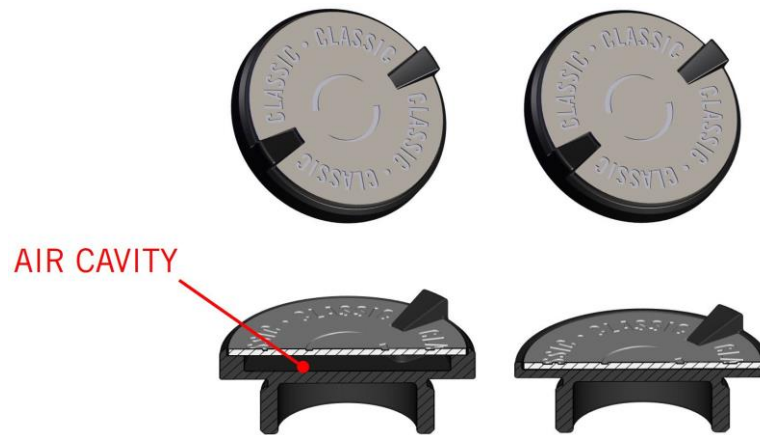

Machines from serial number LS009700 have new knobs and caps.

The new knob is available as spare, same part number F.1.207. The previous version of the cap is no longer available, and the new version will soon be available as a spare part with same part number F.1.208.

Do not hesitate to contact our solutions team with any questions you may have about this technical bulletin.
solutions.usa@lamarzocco.com
206.706.9104 x 101